

Write your name here

Surname

Other names

Pearson Edexcel
International GCSE

Centre Number

--	--	--	--	--	--

Candidate Number

--	--	--	--	--

Human Biology

Unit: 4HB0

Paper: 01

Wednesday 13 January 2016 – Afternoon

Time: 2 hours

Paper Reference

4HB0/01

You must have:

Ruler
Calculator

Total Marks

--

Instructions

- Use **black** ink or ball-point pen.
- **Fill in the boxes** at the top of this page with your name, centre number and candidate number.
- Answer **all** questions.
- Answer the questions in the spaces provided – *there may be more space than you need.*
- Show all the steps in any calculations and state the units.
- Some questions must be answered with a cross in a box ☒. If you change your mind about an answer, put a line through the box ☒ and then mark your new answer with a cross ☒.

Information

- The total mark for this paper is 120.
- The marks for **each** question are shown in brackets – *use this as a guide as to how much time to spend on each question.*

Advice

- Read each question carefully before you start to answer it.
- Write your answers neatly and in good English.
- Try to answer every question.
- Check your answers if you have time at the end.

Turn over ►

P46897A

©2016 Pearson Education Ltd.

1/1/1/1/1/1/1/



PEARSON

Answer ALL questions.

1 For each of the questions (a) to (j), choose an answer **A, B, C** or **D** and put a cross in the box ☒. Mark only one answer for each question. If you change your mind about an answer, put a line through the box ☒ and then mark your new answer with a cross ☒.

(a) Which of these statements is correct for the structure of DNA?

(1)

- A** single-stranded with the base pairs AG and CT
- B** double-stranded with the base pairs AG and CT
- C** single-stranded with the base pairs AT and CG
- D** double-stranded with the base pairs AT and CG

(b) The diagram shows a human skin cell.

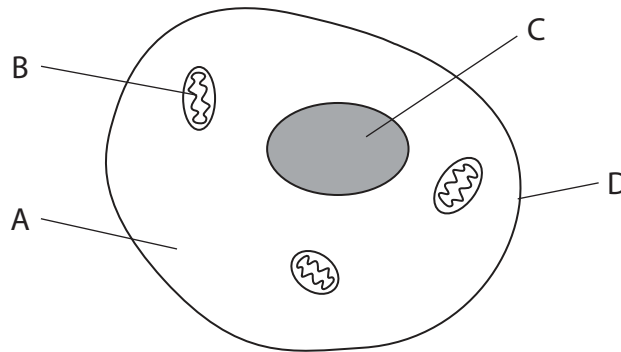

Which structure is the site of aerobic respiration?

(1)

- A**
- B**
- C**
- D**

(c) Which of these is **not** a greenhouse gas?

(1)

- A** carbon dioxide
- B** water vapour
- C** sulphur dioxide
- D** methane



(d) The information on a milk carton shows that 240 ml of milk provides 30% of the recommended daily allowance of calcium.

How much milk would a person need to drink to obtain their recommended daily allowance of calcium?

(1)

- A 270 ml
- B 800 ml
- C 2400 ml
- D 7200 ml

(e) Which of these are human excretory products?

(1)

- A urea and oxygen
- B amino acids and water
- C carbon dioxide and oxygen
- D water and urea

(f) Which disease is caused by a virus?

(1)

- A poliomyelitis
- B schistosomiasis
- C gonorrhoea
- D typhoid



(g) Which of these is used to test for protein in a food sample?

(1)

- A Benedict's solution
- B Biuret reagent
- C universal indicator solution
- D iodine solution

(h) Active transport is the movement of substances

(1)

- A against a concentration gradient using energy
- B against a concentration gradient without using energy
- C down a concentration gradient using energy
- D down a concentration gradient without using energy

(i) The diagram shows a human eye.

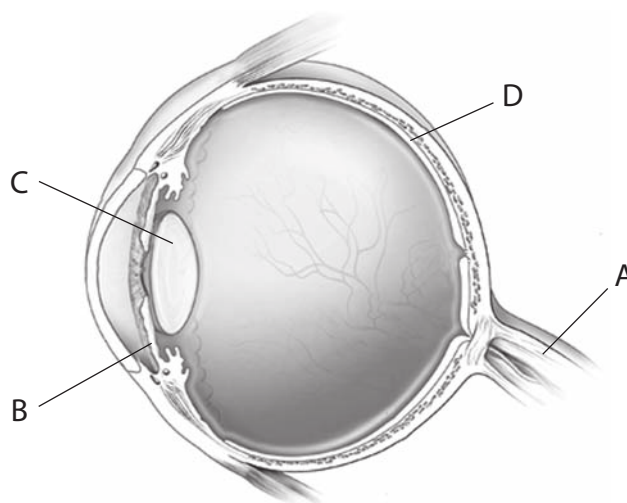

Which part of the eye can focus light?

(1)

- A
- B
- C
- D



(j) What is released when ATP is broken down?

(1)

- A energy
- B oxygen
- C glucose
- D carbon dioxide

(Total for Question 1 = 10 marks)



2 (a) The diagram shows various pieces of scientific apparatus.

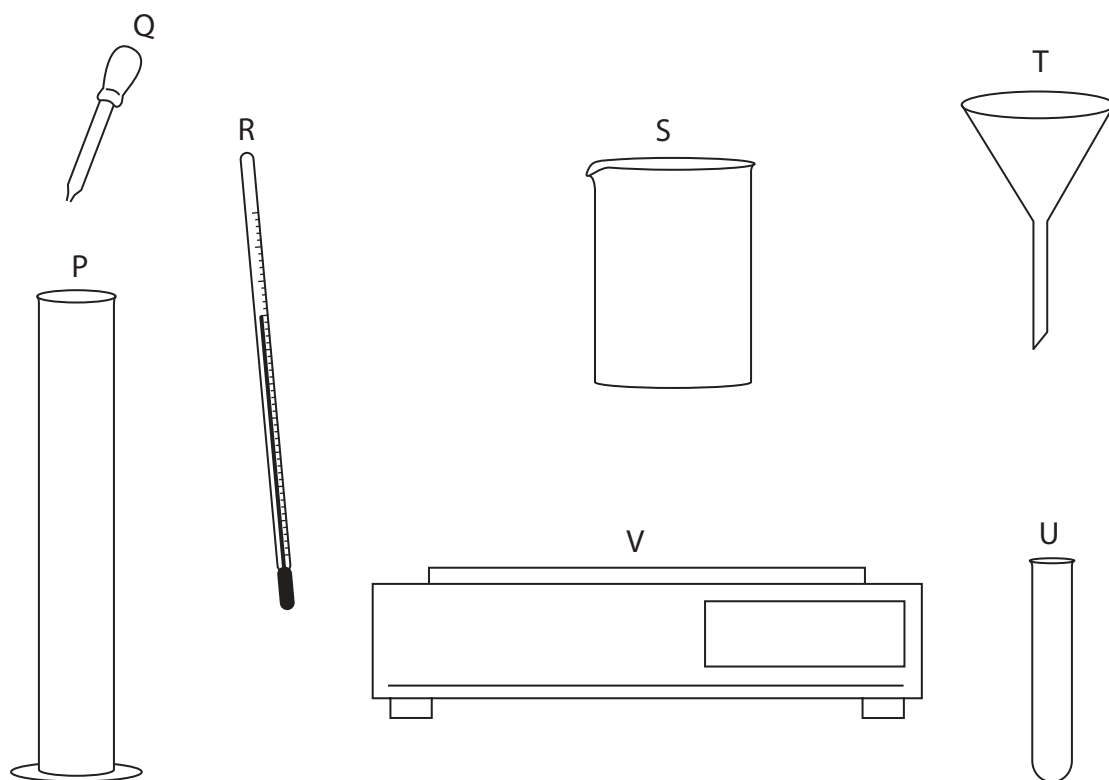

Complete the table with the letters P, Q, R, S, T, U or V to show which piece of apparatus is the most suitable to use for the task shown. You may use each letter once, more than once or not at all.

Task	Letter of apparatus	
Measuring the temperature of the water		(1)
Measuring the mass of sugar		(1)
Adding biuret reagent to a food mixture		(1)
Measuring 17 cm ³ of an enzyme solution		(1)



(b) The apparatus in this diagram can be used to compare the amount of carbon dioxide in inhaled and exhaled air.

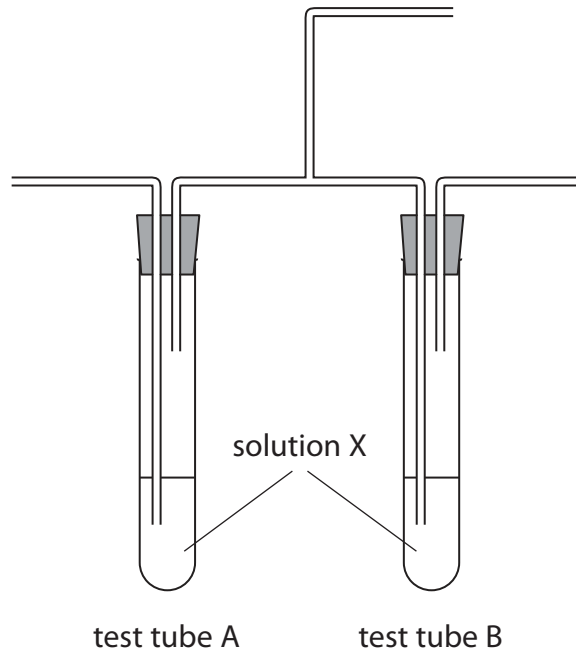

(i) Name solution X.

(1)

(ii) Describe how this apparatus can be used to compare the amount of carbon dioxide in inhaled and exhaled air.

(4)



(c) The table shows the percentage composition of the main gases in inhaled and exhaled air.

Gas	Inhaled (%)	Exhaled (%)
Nitrogen	78	
Oxygen	21	
Carbon dioxide	0.04	4

- (i) Complete the table by giving the percentages of nitrogen and oxygen in exhaled air. (2)
- (ii) Explain the differences in the percentage of gases in inhaled and exhaled air. (4)

.....

.....

.....

.....

.....

.....

.....

.....

.....

.....

.....

(Total for Question 2 = 15 marks)



DO NOT WRITE IN THIS AREA

DO NOT WRITE IN THIS AREA

DO NOT WRITE IN THIS AREA

3 The diagram shows the female reproductive system.

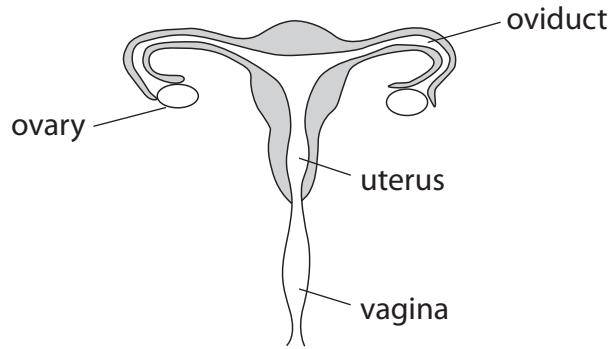

(a) Complete the table by giving the part of the reproductive system where each event takes place.

(3)

Event	Part of the reproductive system
fetus normally grows and develops	
eggs are produced	
fertilisation takes place	

(b) (i) An intrauterine device (IUD) can be used to prevent pregnancy.

Describe how this device works.

(2)

.....

.....

.....

.....

(ii) State an advantage and a disadvantage of using an IUD as a method of contraception compared to using the contraceptive pill.

(2)

Advantage.....

.....

Disadvantage.....

.....

(Total for Question 3 = 7 marks)



4 This question is about parts of the human skeleton.

(a) Draw one straight line from each part of the skeleton to the body organ that it protects.

(3)

Skeleton

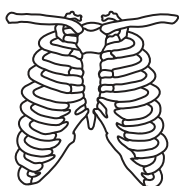

Organ

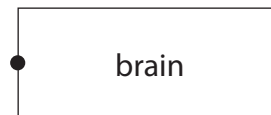
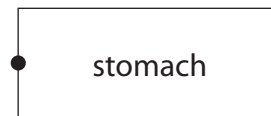
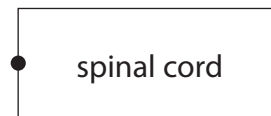
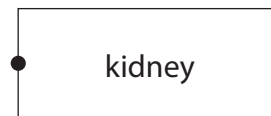
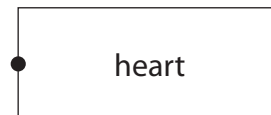

(b) The pelvis is made up of several bones that meet at joints.

One of these joints is labelled in the diagram.

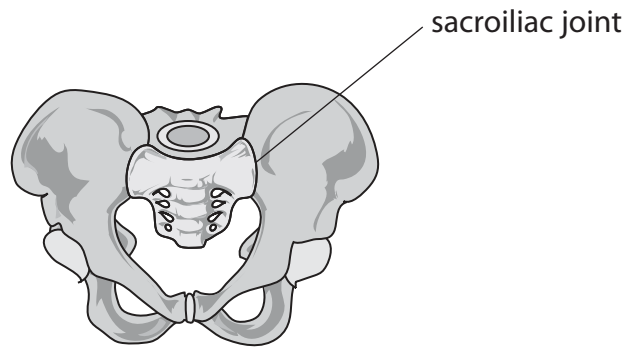

(i) Describe how the joint found between the femur and the pelvis is different from the sacroiliac joint.

(3)

.....

.....

.....

.....

.....

.....

(ii) The pelvis and femur are bones that form part of the appendicular skeleton.

Name two other bones that form part of the appendicular skeleton.

(2)

1.....

2.....



(iii) The femur is an example of a long bone.

Draw a diagram of a section through a long bone.
Label the compact bone, the spongy bone and the epiphysis.

(4)

(Total for Question 4 = 12 marks)

DO NOT WRITE IN THIS AREA

DO NOT WRITE IN THIS AREA

DO NOT WRITE IN THIS AREA



DO NOT WRITE IN THIS AREA

DO NOT WRITE IN THIS AREA

DO NOT WRITE IN THIS AREA

5 This passage is about biological molecules.

Use words from the box to complete the passage.

You may use each word once, more than once or not at all.

(7)

	kidneys	milk	water	bread
liver	energy	calcium	growth	glycogen
glucose	protein	nitrogen	glycerol	fatty acids

Starch is a carbohydrate found in foods such as Starch is made up of repeating units and is found in plants as a short-term store of Animal cells store for a similar function.

Biological molecules called proteins are made up of amino acids. Proteins are used by the body for and repair of body tissues. Amino acids contain the elements carbon, hydrogen, oxygen and Excess amino acids can be broken down in the to form urea.

(Total for Question 5 = 7 marks)



6 This question is about the nutritional content of two foods, X and Y.

- (a) The diagram shows two burning foods, X and Y, being used to increase the temperature of water.

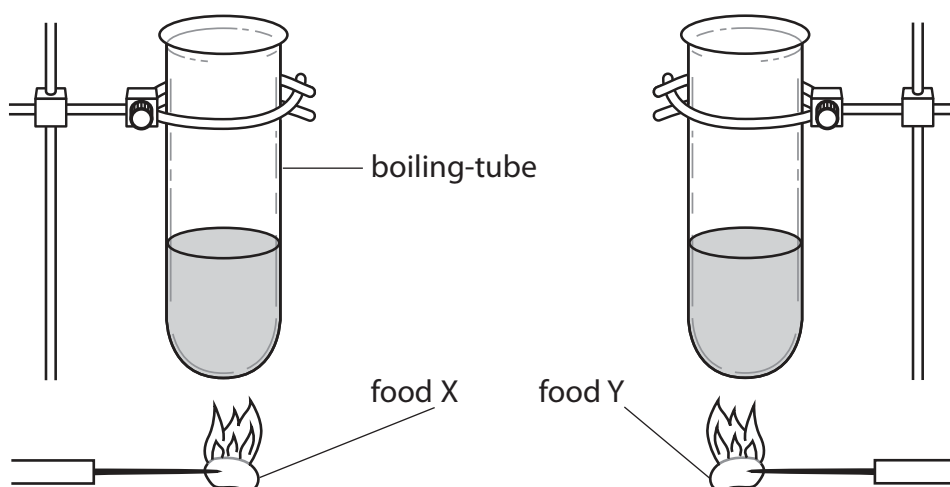

The temperature of the water in each test tube is recorded at the start of the experiment, before the food is set alight. It is recorded again at the end of the experiment, after the food has stopped burning.

Food	Temperature of water in °C	
	at start	at end
X	23	31
Y	20	29

- (i) The initial mass of each food and the volume of water should be kept constant in both experiments. Explain why these variables should be kept constant.

(2)

.....

.....

.....

.....

- (ii) Which food produces the greater increase in the temperature of the water? Show your working.

(1)

.....



(iii) Suggest why one of the foods produces a greater increase in the temperature of the water.

(2)

.....

.....

.....

.....

(b) (i) Describe how food X can be tested for glucose.

(3)

.....

.....

.....

.....

.....

(ii) State two safety precautions that should be taken when testing food for glucose.

(2)

1

2

(Total for Question 6 = 10 marks)

DO NOT WRITE IN THIS AREA

DO NOT WRITE IN THIS AREA

DO NOT WRITE IN THIS AREA



7 (a) A scientist uses this method to investigate the effect of exercise on the pulse rate of four people.

This is the scientist's method.

- measure the pulse rate of each person before they exercise
- the people then exercise for five minutes
- measure the pulse rate at one-minute intervals during exercise
- record the pulse rate in beats per minute (bpm)

(i) Draw a table that could be used to record the scientist's results.

(4)

(ii) Suggest one factor that the scientist should consider to make sure the test is carried out safely.

(1)

.....

.....



(iii) One of the people taking part in the investigation is a cigarette smoker.

Suggest why this person's pulse rate is likely to be higher than the pulse rates of the non-smokers in the group.

(3)

.....

.....

.....

.....

.....

.....

(b) (i) Name the substance in cigarette smoke that can cause lung cancer.

(1)

.....

(ii) Name the substance in cigarette smoke that causes addiction.

(1)

.....

(Total for Question 7 = 10 marks)

DO NOT WRITE IN THIS AREA

DO NOT WRITE IN THIS AREA

DO NOT WRITE IN THIS AREA



8 (a) The diagram shows a sensory neurone attached to part of a sense organ.

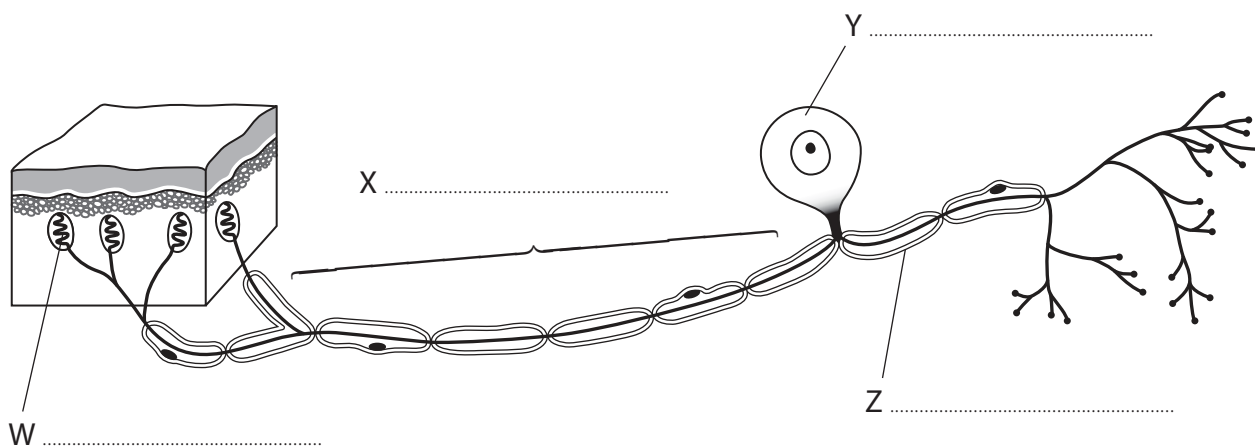

(i) On the diagram, write the names of the structures W, X, Y and Z.

(4)

(ii) State the function of structures W, X, Y and Z.

(4)

W

X

Y

Z

(b) Neurones transmit impulses around the body.
The table lists three types of neurone.

Complete the table by giving the missing information.

(3)

Type of neurone	Impulses transmitted from	Impulses transmitted to
sensory		CNS
motor	CNS	
relay	sensory neurone	



(c) The diagram shows a microscopic gap between two different neurones.

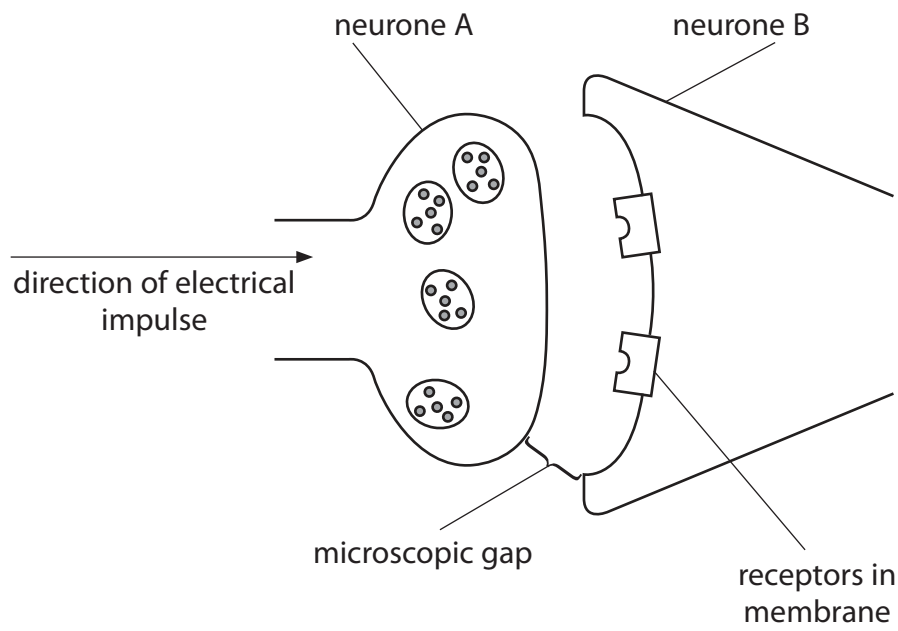

(i) Name the microscopic gap shown in the diagram. (1)

(ii) Describe how an electrical impulse reaching the end of neurone A can produce an impulse in neurone B. (3)

(Total for Question 8 = 15 marks)



9 Insulin is a hormone that helps to regulate the level of glucose in the blood.

Insulin is released by the pancreas and transported to the liver by the blood.

(a) (i) Name a hormone, other than insulin, that is produced by the pancreas. (1)

(ii) Name the blood component that transports insulin from the pancreas to the liver. (1)

(iii) The responses brought about by hormones are different from the responses brought about by neurones. Describe two of these differences. (2)

1

2



(b) The graph shows the glucose and insulin concentration in a person's blood.

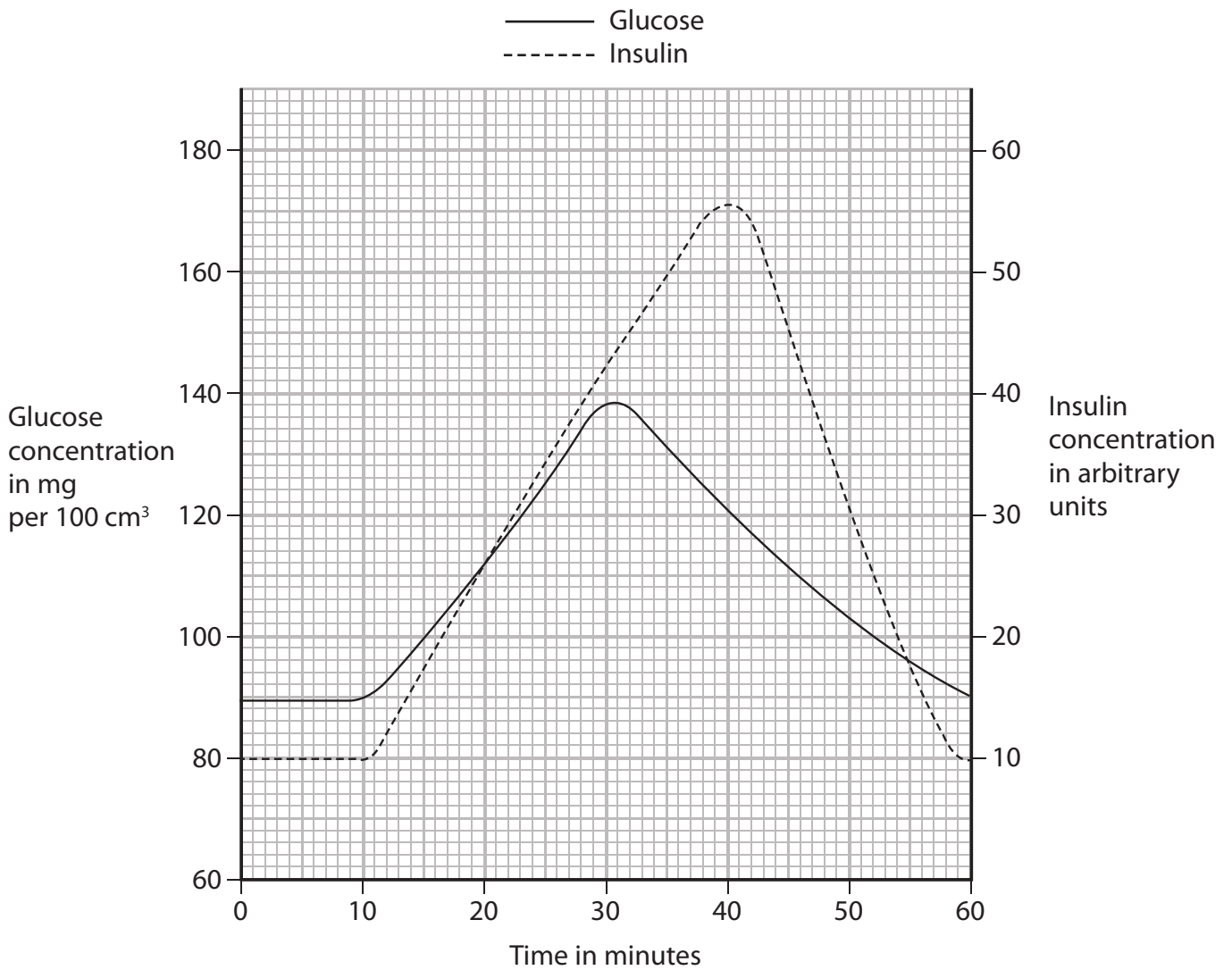

(i) Describe how the graph shows that glucose stimulates the production of insulin.

(2)

.....

.....

.....

.....

(ii) What is the concentration of glucose in the blood when insulin reaches its maximum concentration?

(1)

.....



(c) Explain why excess alcohol may affect the role of the liver in regulating blood glucose levels.

(3)

.....

.....

.....

.....

.....

.....

.....

(Total for Question 9 = 10 marks)

DO NOT WRITE IN THIS AREA

DO NOT WRITE IN THIS AREA

DO NOT WRITE IN THIS AREA



DO NOT WRITE IN THIS AREA

DO NOT WRITE IN THIS AREA

DO NOT WRITE IN THIS AREA

BLANK PAGE



10 (a) The diagram shows a human heart.

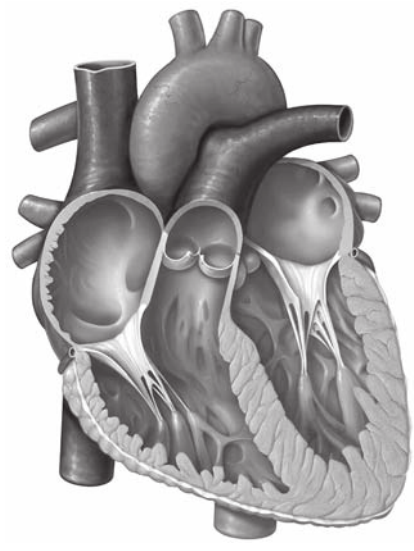

(i) Name the part of the heart that pumps blood to the body. (1)

.....

(ii) Describe how blood is oxygenated before it reaches the heart. (3)

.....
.....
.....
.....
.....
.....
.....
.....

(iii) Describe the structure of the blood vessel that returns oxygenated blood to the heart. (2)

.....
.....
.....
.....



- (b) The table gives information about the heart rate and the volume of blood pumped out of the heart for an athlete and a non-athlete.

	Heart rate in beats per minutes (bpm)	Volume of blood pumped out of the heart in dm^3	
		Per heartbeat	Per minute
athlete	140	0.170	23.8
non-athlete	160	0.120	

- (i) Calculate the volume of blood pumped out of the heart per minute, for the non-athlete.

Show your working.

(2)

volume per minute = dm^3

- (ii) Suggest why the heart of the athlete can pump out more blood per heartbeat than the heart of the non-athlete.

(2)

.....

.....

.....

.....

.....

(Total for Question 10 = 10 marks)



11 The diagram shows the structure of a kidney nephron and its blood supply.

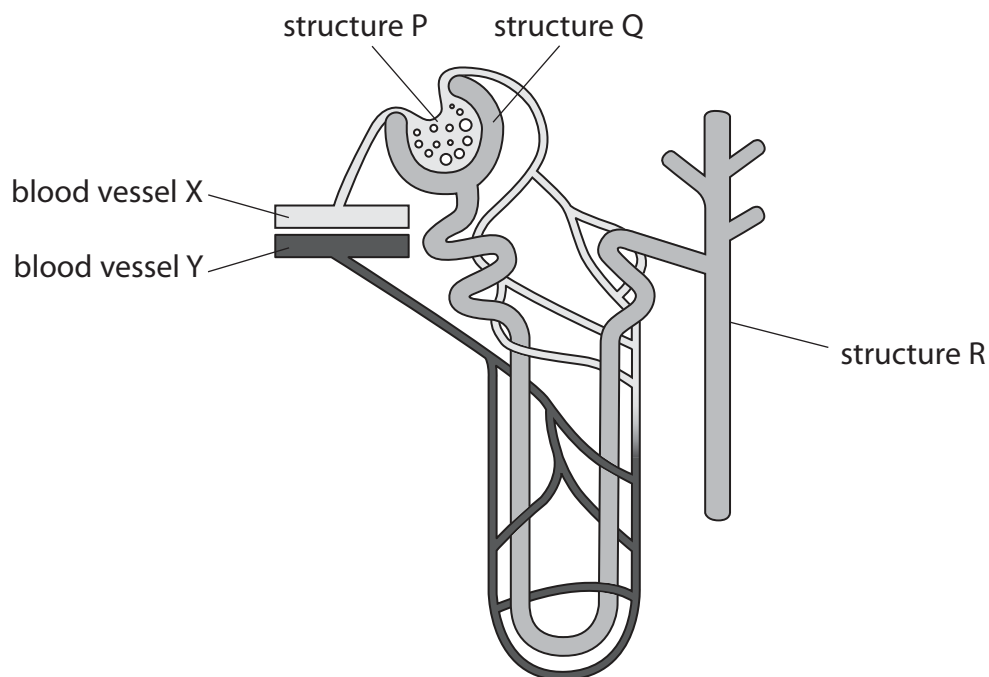

(a) (i) Blood flows through blood vessels that make up structure P.

Which row of the table correctly describes the type of blood vessel found in structure P, and the blood pressure in structure P compared with similar vessels?

(1)

	Type of blood vessel found in structure P	Blood pressure in structure P
<input type="checkbox"/> A	capillary	low
<input type="checkbox"/> B	capillary	high
<input type="checkbox"/> C	artery	low
<input type="checkbox"/> D	artery	high

(ii) Give the name of structure Q.

(1)



(iii) Explain how some materials pass from structure P to structure Q.

(3)

.....

.....

.....

.....

.....

.....

(iv) State why some materials cannot pass from structure P to structure Q.

(1)

.....

.....

(b) The liquid in structure Q contains glucose and urea.

Explain what happens to these substances as they pass along the nephron.

(3)

Glucose.....

.....

Urea.....

.....

DO NOT WRITE IN THIS AREA

DO NOT WRITE IN THIS AREA

DO NOT WRITE IN THIS AREA



(c) The graph shows the percentage of people in different age groups with chronic kidney disease (CKD).

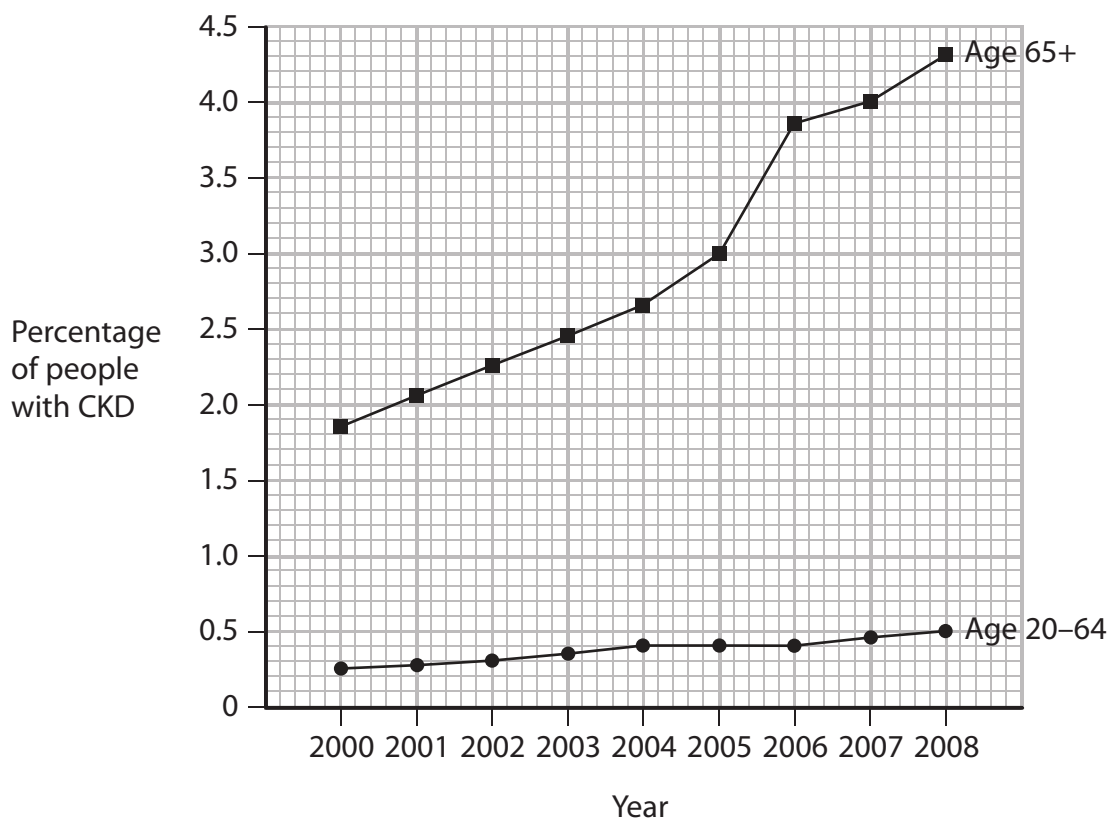

(i) What conclusions can be made from the information shown in the graph?

(3)

.....

.....

.....

.....

.....

.....



(ii) People with CKD often require a kidney transplant.

Suggest why it is not always possible for all people with CKD to have a kidney transplant.

(2)

.....

.....

.....

.....

(Total for Question 11 = 14 marks)

TOTAL FOR PAPER = 120 MARKS

DO NOT WRITE IN THIS AREA

DO NOT WRITE IN THIS AREA

DO NOT WRITE IN THIS AREA



DO NOT WRITE IN THIS AREA

DO NOT WRITE IN THIS AREA

DO NOT WRITE IN THIS AREA

BLANK PAGE



DO NOT WRITE IN THIS AREA

DO NOT WRITE IN THIS AREA

DO NOT WRITE IN THIS AREA

BLANK PAGE



DO NOT WRITE IN THIS AREA

DO NOT WRITE IN THIS AREA

DO NOT WRITE IN THIS AREA

BLANK PAGE

Every effort has been made to contact copyright holders to obtain their permission for the use of copyright material. Pearson Education Ltd. will, if notified, be happy to rectify any errors or omissions and include any such rectifications in future editions.

